

Varenummer: 20167V402SW  
 Beskrivelse: E+G  
 Bred fod holder GN167-V40-2-SW

## Mål

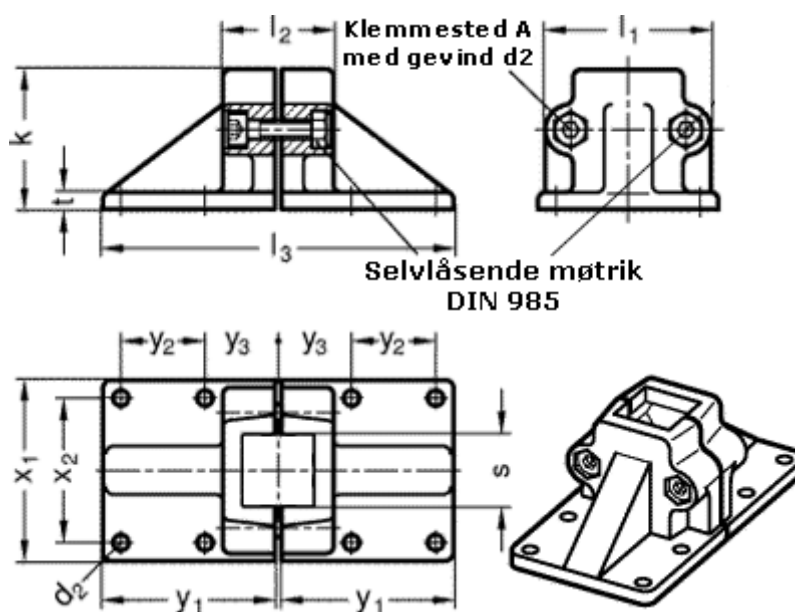

$d2 = 11$	$x1 = 115$
$d3 = M10$	$x2 = 90$
$k = 91$	$y1 = 108$
$l1 = 98$	$y2 = 50$
$l2 = 70$	$y3 = 45$
$l3 = 218$	
$S = V40$	
$t = 14$	